

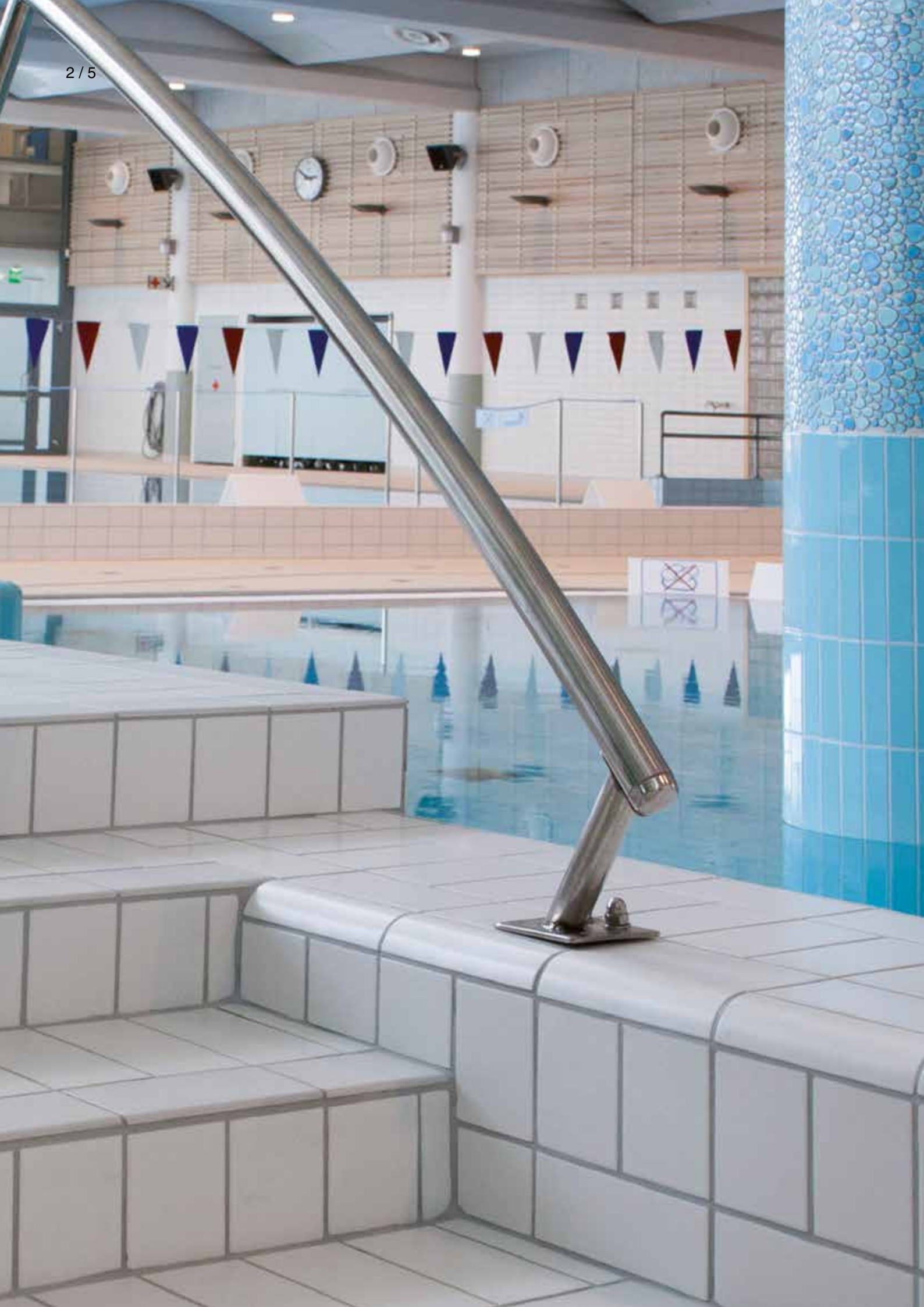

# HÖGANÄS POOL COLLECTION



**Höganäs**  
RICCHETTI GROUP





## INNEHÅLLSFÖRTECKNING

- 4 Presentation
- 7 Symboler
- 8 Serie Vario Color
- 14 Serie Cinca Color
- 18 Serie Arkitekt
- 20 Serie Grynna
- 24 Serie Natura
- 26 Special plattor
- 28 Finnish System
- 30 Zürich System
- 32 Wiesbaden System Hög vattennivå
- 34 Wiesbaden System Låg vattennivå
- 36 Markeringsplattor
- 38 Tätskiktssystem
- 39 Produkt sammanställning

# HÖGANÄS POOL COLLECTION

En badanläggning är ofta en stor investering och kräver noggrann planering redan vid projekteringen. Det gäller att hitta rätt vid val av klinkerplattor, formbitar, ytstrukturer och tätskiktskonstruktioner. Detta är mycket viktiga faktorer för framtida säkerhet, underhåll, ekonomi och drift.

Keramiska plattor är traditionellt det vanligaste materialet som används i simbassänger tack vare dess överlägsna egenskaper när det gäller slitstyrka, hygien, halkdämpande egenskaper och inte minst estetiska värden

CC Höganäs har arbetat med denna typ av projekt i flera decennier och har en gedigen kunskap av keramiska plattor, tätskikt och konstruktioner. Denna kunskap vill vi dela med oss av när det gäller att bygga och renovera bad.

Denna broschyr visar endast ett urval av produkter som vi kan erbjuda för badanläggningar pooler och spa. På vår hemsida [www.cchoganas.se](http://www.cchoganas.se) hittar du vårt kompletta utbud av keramiska plattor och formbitar för badanläggningar. Här kan du även läsa om lämpliga förutsättningar, bassängkonstruktioner, tätskikt, halkdämpning etc.

Vår tekniska avdelning som jobbar i AutoCad kan hjälpa till med 2D/3D ritningar i format upp till A0. Vi kan göra mängdberäkning förslag på tätskiktskonstruktioner och komplett materialoffert för er! Vi ställer naturligtvis upp med personliga möten och vår organisation finns sedan till hjälp från projektering till färdig anläggning







# HÖGANÄS **POOL** COLLECTION

Vissa plattor kan man bara ha på vägg medan andra är gjorda för att användas på både golv och vägg. Dessa symboler används för att du ska hitta rätt platta:

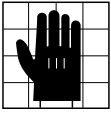

## Vägg, hårt slitage

Kan användas på vägg där det finns extra höga krav på rengörbarhet och hållfasthet.



## Bassänger

Plattor lämpade för bassänger, duschar och tvagningsrum.

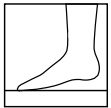

## Barfota golv

Plattor som är lämpade i barfotaområden.



## Kemikalieresistenta.

Gäller för i stort sett alla syror, alkalier och lösningsmedel.



## Golv, gångtrafik

För golv i lokaler med intensiv gångtrafik, t ex kök, hall och vardagsrum men även i offentliga utrymmen.

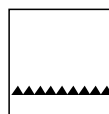

## Halkdämpning

Plattor, som är avsedda för golv, där det föreligger risk för halka. Inom halkdämpande plattor finns olika ytstrukturer, med olika grad av friktion. Halkdämpande ytor förekommer såväl på barfotagolv som på golv man normalt beträder med skor.



## Frostbeständiga.

Kan användas på bl a fasader, altaner, uterum, yttertrappor och entréer.

## PEI

Beständighet mot avnötning av glaserade golvplattor. Skalan löper från 0 till 5, där 0 har lägst beständighet och 5 högst beständighet mot avnötning av glasyren.

## ABC-klass, vattenbegjutna barfotagolv

ABC-klasser innebär A för lägsta friktion och C för högsta. Klasserna används för att ange friktion på vattenbegjutna golv med barfotatrafik i simhallar, poolområden, duschrut och liknande.

## Säkerhetsklasser och användningsområden för barfotautrymmen, grupp ABC

Halksäkerhetsgrupp	Minsta lutningsvinkel	Användningsområde
A	12°	Barfotaområden i huvudsak i torra utrymmen Omklädningsrum Bassängbotten för ej simkunniga, vattendjup >80 cm
B	18°	Barfotaområden som inte omfattas av A Duschar Golv kring bassäng Bassängbotten för ej simkunniga, vattendjup <80 cm Bassängbotten vid höj- och sänkbar botten Bassängbotten vid vågmaskin Plaskbassäng Lejdare till bassäng Trappor med max. bredd 100 cm och med handledare på bägge sidor Lejdare och trappor utanför bassängområde
C	24°	Trappor som leder till bassäng och inte omfattas av B Genomgångsbassäng Lutande bassängkanter

# HÖGANÄS **POOL** COLLECTION

## VARIO COLOR

EN 14411 A1<sub>b</sub> GLASERAD



### MATT

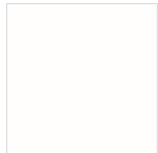

Weiss (901)  
S 1000-N



Hellblau (721)  
S 2020-B



Himmelblau (741)  
S 2040-B



Stahlblau (761)  
S 3040-B



Azurblau (781)  
S 4055-R70B

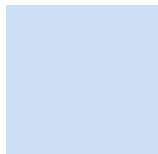

Eisblau (511)  
S 1020-R80B



Pastellblau (521)  
S 1030-R80B



Kornblumenblau (531)  
S 2030-R80B



Royalblau (541)  
S 1020-Y



Dunkelblau (561)  
S 4050-R70B



Ultramarinblau (581)  
S 6030-R70B



Hellgrün (611)  
S 2020-G10Y



Seegrün (641)  
S 2030-G10Y



Maigrün (681)  
S 2050-G10Y

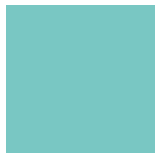

Aquamarin (621)  
S 2020 B30G



Türkis (661)  
S 3030-B30G



Minttürkis (671)  
S 4030-B30G



Lichtgrau (911)  
S 2502-B



Hellgrau (921)  
S 3502 B



Grau (931)  
S 5000-N



Dunkelgrau (951)  
S 7000-N



Anthrazitgrau (971)  
S 8502-B

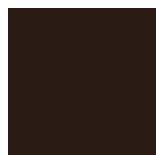

Schwarz (991)  
S 9000-N



Melonengelb (211)  
S 1020-Y



Maisgelb (251)  
S 2030-Y10R



Zinkgelb (281)  
S 1060-Y10R



Gelbbraun (411)  
S 1515-Y40R



Sandbraun (451)  
S 2040-Y20R



Dunkelorange (481)  
S 240-Y40R

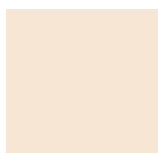

Hellelfenbein (111)  
S 2010-Y20R



Beige (121)  
S 2020-Y20R



Braunbeige (141)  
S 3040-Y30R



Orangebraun (151)  
S 4040-Y40R



Signalbraun (171)  
S 6030-Y50R



Terrabraun (191)  
S 7020-Y40R



Sesam (811)  
S 2010-Y50R



Lachs (821)  
S 3020-Y50R



Sienaerde (841)  
S 4040-Y70R



Sattelbraun (861)  
S 6030-Y70R



Nussbraun (871)  
S 7020-Y70R



Schokobraun (881)  
S 8010 Y70R



# HÖGANÄS POOL COLLECTION

## VARIO COLOR

EN 14411 A1<sub>b</sub> GLASERAD



### BLANK



Schwefelgelb (270)  
S 1060-G90Y



Dahliengelb (470)  
S 2060-Y30R



Orange (490)



Feuerrot (370)  
S 2070-Y90R



Gelbgrün (630)  
S 1060-G50Y



Limette (650)  
S 3040-G30Y

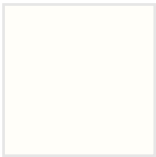

Weiss (900)  
S 1000-N



Lichtblau (710)  
S 2030-B10G



Azur dunkel (790)  
S 7020-R90B



Kobaltblau (590)  
S 6030-R70B



Schwarz (990)  
S 5000-N

### B-YTA

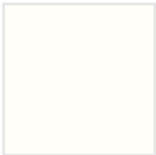

Weiss (906)  
S 1000-N



Lichtblau (716)  
S 2030-B10G



Azur dunkel (796)  
S 7020-R90B



Azurblau (786)  
S 4055-R70B

### C-YTA



Weiss (908)  
S 1000-N



Lichtblau (718)  
S 2030-B10G



Azur dunkel (798)  
S 7020-R90B



Azurblau (788)  
S 4055-R70B





# HÖGANÄS POOL COLLECTION

## VARIO COLOR

EN 14411 A<sub>1</sub> GLASERAD



	Färger	Färgkod FC	NCS	PEI	M 12,5 x 25 cm (119x244x7,5 mm)	M 25 x 25 cm (244x244x7,5 mm)	M 12,5 x 12,5 cm (119x119x7,5 mm)	M 25 x 6,2 cm (244x56x7,5 mm)
					Artikel	Artikel	Artikel	Artikel
	<b>MATT</b>							
	Melonegelb	211	S 1020-Y	IV	31 1200 211	32 2424 211	32 1212 211	
	Maisgelb	251	S 2030-Y10R	III	31 1200 251	32 2424 251	32 1212 251	
	Zinkgelb	281	S 1060-Y10R	III	31 1200 281	32 2424 281	32 1212 281	
	Gelbbraun	411	S 1515-Y40R	IV	31 1200 411	32 2424 411	32 1212 411	
	Sandbraun	451	S 2040-Y20R	III	31 1200 451	32 2424 451	32 1212 451	
	Dunkelorange	481	S 2050-Y30R	III	31 1200 481	32 2424 481	32 1212 481	
	Hellgrün	611	S 2020-G10Y	IV	31 1200 611	32 2424 611	32 1212 611	
	Seegrün	641	S 2030-G10Y	III	31 1200 641	32 2424 641	32 1212 641	
	Maigrün	681	S 2050-G10Y	III	31 1200 681	32 2424 681	32 1212 681	
	Aquamarin	621	S 2020 B30G	IV	31 1200 621	32 2424 621	32 1212 621	
	Türkis	661	S 3030-B30G	III	31 1200 661	32 2424 661	32 1212 661	
	Minttürkis	671	S 4030-B30G	III	31 1200 671	32 2424 671	32 1212 671	
	Hellblau	721	S 2020-B	IV	31 1200 721	32 2424 721	32 1212 721	
	Himmelblau	741	S 2040-B	IV	31 1200 741	32 2424 741	32 1212 741	
	Stahlblau	761	S 3040-B	III	31 1200 761	32 2424 761	32 1212 761	
	Azurblau	781	S 4055-R70B	III	31 1200 781	32 2424 781	32 1212 781	
	Eisblau	511	S 1020-R80B	IV	31 1200 511	32 2424 511	32 1212 511	
	Pastellblau	521	S 1030-R80B	IV	31 1200 521	32 2424 521	32 1212 521	
	Kornblumenblau	531	S 2030-R80B	III	31 1200 531	32 2424 531	32 1212 531	
	Royalblau	541	S 3040-R80B	II	31 1200 541	32 2424 541	32 1212 541	
	Dunkelblau	561	S 4050-R70B	II	31 1200 561	32 2424 561	32 1212 561	
	Ultramarinblau	581	S 6030-R70B	II	31 1200 581	32 2424 581	32 1212 581	
	Sesam	811	S 2010-Y50R	IV	31 1200 811	32 2424 811	32 1212 811	
	Lachs	821	S 3020-Y50R	IV	31 1200 821	32 2424 821	32 1212 821	
	Sienaerde	841	S 4040-Y70R	III	31 1200 841	32 2424 841	32 1212 841	
	Sattelbraun	861	S 6030-Y70R	II	31 1200 861	32 2424 861	32 1212 861	
	Nussbraun	871	S 7020-Y70R	II	31 1200 871	32 2424 871	32 1212 871	
	Schokobraun	881	S 8010 Y70R	II	31 1200 881	32 2424 881	32 1212 881	
	Hellelfenbein	111	S 2010-Y20R	IV	31 1200 111	32 2424 111	32 1212 111	
	Beige	121	S 2020-Y20R	IV	31 1200 121	32 2424 121	32 1212 121	
	Braunbeige	141	S 3040-Y30R	III	31 1200 141	32 2424 141	32 1212 141	
	Orangebraun	151	S 4040-Y40R	III	31 1200 151	32 2424 151	32 1212 151	
	Signalbraun	171	S 6030-Y50R	II	31 1200 171	32 2424 171	32 1212 171	
	Terrabraun	191	S 7020-Y40R	II	31 1200 191	32 2424 191	32 1212 191	
	Weiss	901	S 1000-N	IV	31 1200 901	32 2424 901	32 1212 901	33 2116 901
	Lichtgrau	911	S 2502-B	IV	31 1200 911	32 2424 911	32 1212 911	
	Hellgrau	921	S 3502 B	III	31 1200 921	32 2424 921	32 1212 921	
	Grau	931	S 5000-N	III	31 1200 931	32 2424 931	32 1212 931	
	Dunkelgrau	951	S 7000-N	II	31 1200 951	32 2424 951	32 1212 951	
	Anthrazitgrau	971	S 8502-B	II	31 1200 971	32 2424 971	32 1212 971	
	Schwarz	991	S 9000-N	II	31 1200 991	32 2424 991	32 1212 991	
	<b>BLANK</b>							
	Schwefelgelb	270	S 1060-G90Y	II	31 1200 270	32 2424 270	32 1212 270	
	Dahliengelb	470	S 2060-Y30R	II	31 1200 470	32 2424 470	32 1212 470	
	Orange	490		II	31 1200 490	32 2424 490	32 1212 490	
	Feuerrot	370	S 2070-Y90R	II	31 1200 370	32 2424 370	32 1212 370	
	Gelbgrün	630	S 1060-G50Y	II	31 1200 630	32 2424 630	32 1212 630	
	Limette	650	S 3040-G30Y	II	31 1200 650	32 2424 650	32 1212 650	
	Kobaltblau	590	S 6030-R70B	II	31 1200 590	32 2424 590	32 1212 590	
	Weiss	900	S 1000-N	III	31 1200 900	32 2424 900	32 1212 900	33 2116 900
	Lichtblau	710	S 2030-B10G	III	31 1200 710	32 2424 710	32 1212 710	33 2116 710
	Azur dunkel	790	S 7020-R90B	II	31 1200 790	32 2424 790	32 1212 790	
	Schwarz	990	S 9000-N	I	31 1200 990	32 2424 990	32 1212 990	
	<b>B-YTA</b>							
	Weiss	906	S 1000-N	IV	31 1200 906	32 2424 906	32 1212 906	
	Lichtblau	716	S 2030-B10G	IV	31 1200 716	32 2424 716	32 1212 716	
	Azur dunkel	796	S 7020-R90B	III	31 1200 796	32 2424 796	32 1212 796	
	Azurblau	786	S 4055-R70B	III	31 1200 786	32 2424 786	32 1212 786	
	<b>C-YTA</b>							
	Weiss	908	S 1000-N	IV	31 1200 908	32 2424 908	32 1212 908	
	Lichtblau	718	S 2030-B10G	IV	31 1200 718	32 2424 718	32 1212 718	
	Azur dunkel	798	S 7020-R90B	III	31 1200 798	32 2424 798	32 1212 798	
	Azurblau	788	S 4055-R70B	III	31 1200 788	32 2424 788	32 1212 788	

# HÖGANÄS **POOL** COLLECTION

## VARIO COLOR FORMBITAR

EN 14411 Al<sub>b</sub> GLASERAD

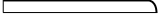
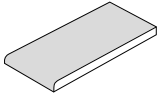
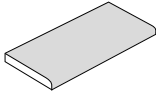
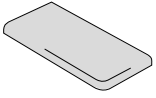
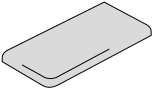
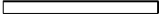
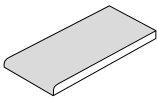
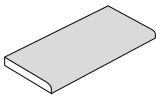
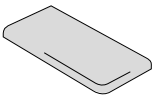
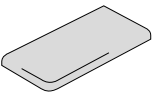

Alla färger och format kan fås med glaserade, rundade kanter eller enbart glaserade kanter.  
Färgkoden, FC hittar du i tabellen på sida 11. Ex. Vit matt glaserad rundad långkant: 31 1200 901-LR

				
<b>GLASERAD RUNDAD KANT</b>	<b>GLASERAD RUNDAD KORTKANT</b> 119x244x7,5 mm 31 1200 + FC-KR	<b>GLASERAD RUNDAD LÅNGKANT</b> 119x244x7,5 mm 31 1200 + FC-LR	<b>HÖRNPLATTA RUNDAD, HÖGER</b> 119x244x7,5 mm 31 1200 + FC-ERR	<b>HÖRNPLATTA RUNDAD, VÄNSTER</b> 119x244x7,5 mm 31 1200 + FC-ERL
				
<b>GLASERAD KANT</b>	<b>GLASERAD KORTKANT</b> 119x244x7,5 mm 31 1200 + FC-KK	<b>GLASERAD LÅNGKANT</b> 119x244x7,5 mm 31 1200 + FC-LK	<b>HÖRNPLATTA, HÖGER</b> 119x244x7,5 mm 31 1200 + FC-EKR	<b>HÖRNPLATTA, VÄNSTER</b> 119x244x7,5 mm 31 1200 + FC-EKL

EN 14411 Al<sub>a</sub> GLASERAD

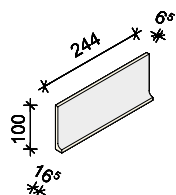

**SOCKEL**  
244x100x6,5 mm  
66 4000 690 Oglaserad  
66 4000 901 Vit matt  
66 4000 900 Vit blank  
66 4000 + FC

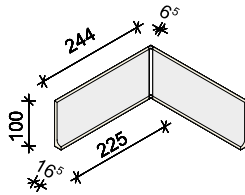

**INNERHÖRN**  
244x100x6,5 mm  
66 4002 690 Oglaserad  
66 4002 901 Vit matt  
66 4002 900 Vit blank  
66 4000 + FC

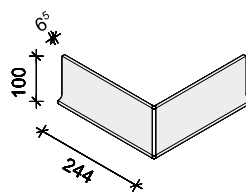

**YTTERHÖRN**  
244x100x6,5 mm  
66 4007 690 Oglaserad  
66 4007 901 Vit matt  
66 4007 900 Vit blank  
66 4000 + FC



# HÖGANÄS **POOL** COLLECTION

## VARIO COLOR FORMBITAR

EN 14411 Al<sub>2</sub>O<sub>3</sub> GLASERAD



Önskas andra färger se färgkod FC på sidan 11. Radius formbitarna kan fås med en halkdämpad yta.

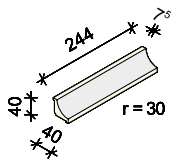

### HÅLKÄLSPLATTA

40x244x40 mm

66 4100 690 Oglaserad  
66 4100 901 Vit matt  
66 4100 900 Vit blank  
66 4100 + FC

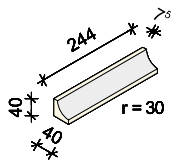

### HÅLKÄLSPLATTA STOPP

40x244x40 mm

66 4101 690 Oglaserad  
66 4101 901 Vit matt  
66 4101 900 Vit blank  
66 4101 + FC

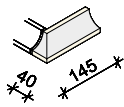

### HÅLKÄLSPLATTA VÄNSTER HÖRN

40x145x40 mm

66 4104 690 Oglaserad  
66 4104 901 Vit matt  
66 4104 900 Vit blank  
66 4104 + FC

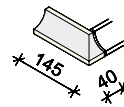

### HÅLKÄLSPLATTA HÖGER HÖRN

40x145x40 mm

66 4106 690 Oglaserad  
66 4106 901 Vit matt  
66 4106 900 Vit blank  
66 4106 + FC

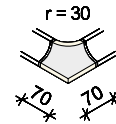

### 3-VÄGS YTTERHÖRN

70x70x40 mm

66 4107 690 Oglaserad  
66 4107 901 Vit matt  
66 4107 900 Vit blank  
66 4107 + FC

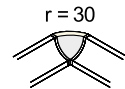

### 3-VÄGS INNERHÖRN

r30 mm

66 4102 690 Oglaserad  
66 4102 901 Vit matt  
66 4102 900 Vit blank  
66 4102 + FC

### RADIUS 30 MM

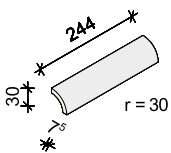

### HÅLKÄLSPLATTA

30x244 mm

66 9450 690 Oglaserad  
66 9450 901 Vit matt  
66 9450 900 Vit blank  
66 9450 + FC

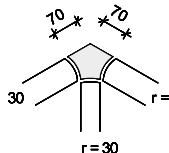

### 3-VÄGS INNERHÖRN

r30 mm

66 9452 690 Oglaserad  
66 9452 901 Vit matt  
66 9452 900 Vit blank  
66 9452 + FC

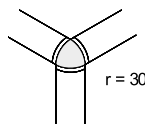

### 3-VÄGS YTTERHÖRN

r30 mm

66 9453 690 Oglaserad  
66 9453 901 Vit matt  
66 9453 900 Vit blank  
66 9453 + FC

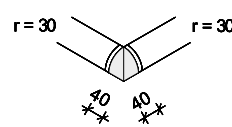

### 2-VÄGS YTTERHÖRN

r30 mm

66 9454 690 Oglaserad  
66 9454 901 Vit matt  
66 9454 900 Vit blank  
66 9454 + FC

### RADIUS 60 MM

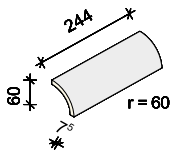

### HÅLKÄLSPLATTA

60x244 mm

66 6450 690 Oglaserad  
66 6450 901 Vit matt  
66 6450 900 Vit blank  
66 6450 + FC

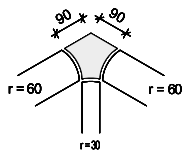

### 3-VÄGS INNERHÖRN

r60 mm

66 6462 690 Oglaserad  
66 6462 901 Vit matt  
66 6462 900 Vit blank  
66 6462 + FC

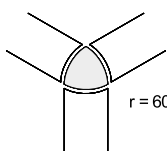

### 3-VÄGS YTTERHÖRN

r60 mm

66 6453 690 Oglaserad  
66 6453 901 Vit matt  
66 6453 900 Vit blank  
66 6453 + FC

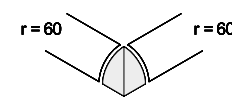

### 2-VÄGS YTTERHÖRN

r60 mm

66 6454 690 Oglaserad  
66 6454 901 Vit matt  
66 6454 900 Vit blank  
66 6454 + FC

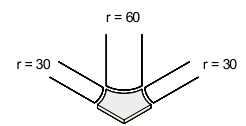

### 3-VÄGS YTTERHÖRN

r30xr30xr60x7,5 mm

66 6457 690 Oglaserad  
66 6457 901 Vit matt  
66 6457 900 Vit blank  
66 6457 + FC



# HÖGANÄS POOL COLLECTION

## CINCA COLOR

EN 14411 B1<sub>a</sub> GLASERAD



White  
NCS S 0502-R



Pearl Grey  
NCS S 2000-N

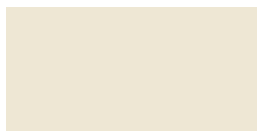

Jasmine  
NCS S 2005-Y20R



Mint Green  
NCS S 2020-G50Y



Ice Blue  
NCS S 1010-R90B



Silver Grey  
NCS S 2500-N



Sand  
NCS S 2010-G90Y



Water Green  
NCS S 1010-G10Y



Sky Blue  
NCS S 2020-B



Steel Grey  
NCS S 3500-N



Beige  
NCS S 3010-Y30R



Sea Green  
NCS S 4020-B90G



Atlas Blue  
NCS S 3030-R90B



Lead Grey  
NCS S 4500-N



Kalahari Beige  
NCS S 2020-Y10R



Victorian Green  
NCS S 7030-B70G



Caribbean Blue  
NCS S 1040-B



Deep Grey  
NCS S 5500-N



Bahamas Beige  
NCS S 3010-Y30R



Petrol Blue (5518)  
NCS S 5040-R90B



Antracite Grey  
NCS S 7502-B



Tangerine  
NCS S 1060-Y60R



Cobalt (5588)  
NCS S 6040-R70B



Black  
NCS S 9500-N



Cognac  
NCS S 5040-Y60R

# HÖGANÄS POOL COLLECTION

## CINCA COLOR

EN 14411 B1<sub>a</sub> GLASERAD



	Färger	Färgkod	NCS	M 12,5 x 25 cm (119x244x7 mm)	M 10 x 20 cm (96x196x7 mm)
		FC		Artikel	Artikel
	<b>MATT</b>				
	White	5500	S 0502-R	CC550025	CC550020
	Ice Blue	5510	S 1010-R90B	CC551025	
	Sky Blue	5512	S 2020-B	CC551225	
	Atlas Blue	5514	S 3030-R90B	CC551425	
	Caribbean Blue	5515	S 1040-B	CC551525	CC551520
	Petrol Blue	5518	S 5040-R90B	CC551825	
	Cobalt	5599	S 6040-R70B	CC559925	CC559920
	Pearl Grey	5501	S 2000-N	CC550125	
	Silver Grey	5502	S 2500-N	CC550225	
	Steel Grey	5503	S 3500-N	CC550325	
	Lead Grey	5504	S 4500-N	CC550425	
	Deep Grey	5505	S 5500-N	CC550525	
	Antracite Grey	5507	S 7502-B	CC550725	
	Black	5509	S 9500-N	CC550920	CC550920
	Jasmine	5540	S 2005-Y20R	CC554025	
	Sand	5541	S 2010-G90Y	CC554125	
	Beige	5530	S 3010-Y30R	CC553025	
	Kalahari Beige	5542	S 2020-Y10R	CC554225	
	Bahamas Beige	5532	S 3010-Y30R	CC553225	
	Tangerine	5588	S 1060-Y60R	CC558825	
	Cognac	5537	S 5040-Y60R	CC553725	
	Mint Green	5581	S 2020-G50Y	CC558125	
	Water Green	5583	S 1010-G10Y	CC558325	
	Sea Green	5523	S 4020-B90G	CC552325	
	Victorian Green	5595	S 7030-B70G	CC559525	
	<b>BLANK</b>				
	White	5000	S 0502-R	CC500025	CC500020
	Caribbean Blue	5015	S 1040-B	CC501525	CC501520
	Cobalt	5099	S 6040-R70B	CC509925	CC509920
	Black	5009	S 9500-N	CC500925	CC500920
	<b>B-YTA</b>				
	White	5500	S 0502-R	CC550025AD1	CC550020AD1
	Caribbean Blue	5515	S 1040-B	CC551525AD1	CC551520AD1
	Cobalt	5599	S 6040-R70B	CC559925AD1	CC559920AD1
	Black	5509	S 9500-N	CC550925AD1	CC550920AD1
	Jasmine	5540	S 2005-Y20R	CC554025AD1	
	Water Green	5583	S 1010-G10Y	CC558325AD1	
	Sea Green	5523	S 4020-B90G	CC552325AD1	
	<b>C-YTA</b>				
	White	5500	S 0502-R	CC550025AD2	CC550020AD2
	Caribbean Blue	5515	S 1040-B	CC551525AD2	CC551520AD2
	Cobalt	5599	S 6040-R70B	CC559925AD2	CC559920AD2
	Black	5509	S 9500-N		CC550920AD2
	Jasmine	5540	S 2005-Y20R	CC554025AD2	
	Water Green	5583	S 1010-G10Y	CC558325AD2	

# HÖGANÄS **POOL** COLLECTION

## CINCA COLOR FORMBITAR

EN 14411 B1<sub>a</sub> GLASERAD





# HÖGANÄS **POOL** COLLECTION

## CINCA COLOR FORMBITAR

EN 14411 BI<sub>a</sub> GLASERAD



De färger som formbitarna kan fås i framgår i tabellen på sidan 15 där du även hittar respektive färgkod, FC. Se färgkod för M10x20 på sida 15. Ex. Vit matt glaserad långkant i 119x244 mm CC550025BIG  
Observera att formaten 96 x 196 mm finns i begränsat antal färger.



### GLASERAD KORTKANT, BIP

**96x196x7 mm**

Art. nr. CC + FC + 20 + BIP

Art. nr. CC + FC + 20 + AD1 + BIP (B Yta)

Art. nr. CC + FC + 20 + AD2 + BIP (C Yta)

**119x244x7 mm**

Art. nr. CC + FC + 25 + BIP

Art. nr. CC + FC + 25 + AD1 + BIP (B Yta)

Art. nr. CC + FC + 25 + AD2 + BIP (C Yta)

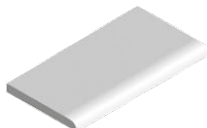

### GLASERAD LÅNGKANT, BIG

**96x196x7 mm**

Art. nr. CC + FC + 20 + BIG

Art. nr. CC + FC + 20 + AD1 + BIG (B Yta)

Art. nr. CC + FC + 20 + AD2 + BIG (C Yta)

**119x244x7 mm**

Art. nr. CC + FC + 25 + BIG

Art. nr. CC + FC + 25 + AD1 + BIG (B Yta)

Art. nr. CC + FC + 25 + AD2 + BIG (C Yta)



### HÖRNPLATTA, HÖGER, B2D

**96x196x7 mm**

Art. nr. CC + FC + 20 + B2D

Art. nr. CC + FC + 20 + AD1 + B2D (B Yta)

Art. nr. CC + FC + 20 + AD2 + B2D (C Yta)

**119x244x7 mm**

Art. nr. CC + FC + 25 + B2D

Art. nr. CC + FC + 25 + AD1 + B2D (B Yta)

Art. nr. CC + FC + 25 + AD2 + B2D (C Yta)

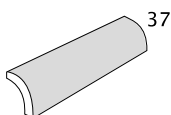

### HÅLKÅLSPLATTA, CX

**196x37x7 mm**

Art. nr. CC + FC + 20 + CX

Art. nr. CC + FC + 20 + AD1 + CX (B Yta)

Art. nr. CC + FC + 20 + AD2 + CX (C Yta)

**244x37x7 mm**

Art. nr. CC + FC + 25 + CX

Art. nr. CC + FC + 25 + AD1 + CX (B Yta)

Art. nr. CC + FC + 25 + AD2 + CX (C Yta)

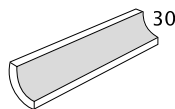

### HÅLKÅLSPLATTA, CV

**196x30x7 mm**

Art. nr. CC + FC + 20 + CV

Art. nr. CC + FC + 20 + AD1 + CV (B Yta)

Art. nr. CC + FC + 20 + AD2 + CV (C Yta)

**244x30x7 mm**

Art. nr. CC + FC + 25 + CV

Art. nr. CC + FC + 25 + AD1 + CV (B Yta)

Art. nr. CC + FC + 25 + AD2 + CV (C Yta)



### HÖRNPLATTA, VÄNSTER, B2E

**96x196x7 mm**

Art. nr. CC + FC + 20 + B2E

Art. nr. CC + FC + 20 + AD1 + B2E (B Yta)

Art. nr. CC + FC + 20 + AD2 + B2E (C Yta)

**119x244x7 mm**

Art. nr. CC + FC + 25 + BIG

Art. nr. CC + FC + 25 + AD1 + B2E (B Yta)

Art. nr. CC + FC + 25 + AD2 + B2E (C Yta)

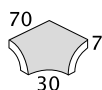

### 3-VÄGS YTTERHÖRN, AIXC

**70x30x7 mm**

Art. nr. CC + FC + 20 + AIXC

Art. nr. CC + FC + 20 + AD1 + AIXC (B Yta)

Art. nr. CC + FC + 20 + AD2 + AIXC (C Yta)

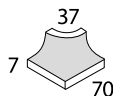

### 3-VÄGS YTTERHÖRN, AE

**70x37x7 mm**

Art. nr. CC + FC + 20 + AE

Art. nr. CC + FC + 20 + AD1 + AE (B Yta)

Art. nr. CC + FC + 20 + AD2 + AE (C Yta)



### 3-VÄGS INNERHÖRN, AICV

**146x37x7 mm**

Art. nr. CC + FC + 20 + AICV

Art. nr. CC + FC + 20 + AD1 + AICV (B Yta)

Art. nr. CC + FC + 20 + AD2 + AICV (C Yta)



### 3-VÄGS YTTERHÖRN, AECX

**146x37x7 mm**

Art. nr. CC + FC + 20 + AECX

Art. nr. CC + FC + 20 + AD1 + AECX (B Yta)

Art. nr. CC + FC + 20 + AD2 + AECX (C Yta)

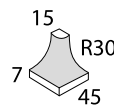

### 2-VÄGS YTTERHÖRN, AECV

**45x15x7 mm**

Art. nr. CC + FC + 20 + AECV

Art. nr. CC + FC + 20 + AD1 + AECV (B Yta)

Art. nr. CC + FC + 20 + AD2 + AECV (C Yta)

# HÖGANÄS **POOL** COLLECTION

## ARKITEKT

EN 14411 B1<sub>a</sub> GLASERAD



Här visar vi enbart en liten del av Arkitekts pool program.

**Hela Arkitekt Pool kollektionen hittar ni i en separat broschyr på vår hemsida --> [www.cchoganas.se/downloads](http://www.cchoganas.se/downloads)**



RAL 9016  
NCS 1000-N



RAL 230 60 20  
NCS 3030-B10G

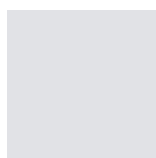

RAL 7047  
NCS 2002-Y50R

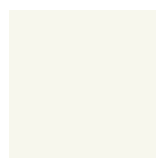

RAL 080 90 05  
NCS 1005-Y20R



RAL 080 80 60 Matt  
NCS 1050-Y10R



RAL 2003 Matt  
NCS 2060-Y60R



RAL 230 70 15  
NCS 3030-B



RAL 240 40 20  
NCS 5030-B

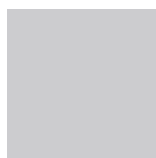

RAL 000 80 00  
NCS 3000-N

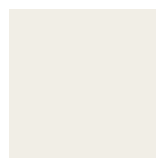

RAL 100 90 05  
NCS 1505-G90Y



RAL 1018 Blank  
NCS 0570-Y



RAL 2010 Blank  
NCS 2060-Y60R



RAL 200 80 20  
NCS 2020-B60G



RAL 260 60 30  
NCS 3030-R90B

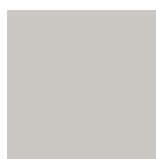

RAL 000 75 00  
NCS 3502-Y



RAL 080 90 10  
NCS 1005-Y40R



RAL 075 70 70  
NCS 2060-Y10R



RAL 3000  
NCS 2570-Y90R



RAL 200 60 20  
NCS 3030-B50G



RAL 260 30 35  
NCS 4040-R80B



RAL 000 55 00  
NCS 4502-Y



RAL 080 80 10  
NCS 2010-Y20R



RAL 100 80 80  
NCS 1060-G60Y



RAL 030 40 50  
NCS 2070-Y90R



RAL 200 40 30  
NCS 5030-B30G



RAL 5002  
NCS 5540-R70B



RAL 000 40 00  
NCS 7500-N



RAL 000 15 00  
NCS 8500-N



RAL 110 50 50  
NCS 4040-G40Y



RAL 3004  
NCS 6030-R

# HÖGANÄS POOL COLLECTION

## ARKITEKT

EN 14411 BI<sub>a</sub> GLASERAD



	RAL	NCS	M 2,5 x 2,5 cm (23x23x6 mm)			M 12,5 x 25 cm (119x244x6 mm)			
			Matt*	Blank*	R10/B*	Matt	Blank	B	C
	9016	1000-N	0277038	0277148	5287368	762090	762101	770346	772385
	100 90 05	1505-G90Y	5275838	5338248					
	080 90 05	1005-Y20R	0277518	0277628					
	080 90 10	1505-Y30R	0296048			790152	891442	891490	891523
	080 80 10	2010-Y20R	5275728						
	000 75 00	3502-Y	0276708	0297558	5354128				
	7047	2002-Y50R	0276818	0276928					
	000 80 00	3000-N	5336148						
	000 55 00	4502-Y	0290008	0290118					
	000 40 00	7500-N	5154848	5227868					
	000 15 00	8500-N	0276558	0276668	5338468	764503	764514	772363	772396
	3004	6030-R	0295018						
	200 80 20	2020-B50G	0278808	0278768		775751	775762		
	200 60 20	3030-B50G	5419448	5419668					
	200 40 30	5030-B30G	5352728						
	230 70 15	2020-B10G	0278918	0279028	5295808	762112	762123	770350	772400
	230 60 20	3030-B	5353058						
	240 40 20	5030-B	5419338	5419558		542036	542051		
	260 60 30	3030-R90B	0279358	0279248		775795	775806	802883	896084
	260 30 35	4050-R80B	5171428	0279138		891416	798436	896073	896095
	5002	4550-R70B	0276448	0276338	5305828	765015	765026	772352	772374
	110 50 50	4040-G40Y	5422358	5422508					
	100 80 80	1060-G60Y	5422248	5422468					
	075 70 70	2060-Y10R	5352468						
	080 80 60	1050-Y10R	5337108						
	1018	0570-Y		0276118					
	2003	2060-Y60R	5204658						
	2010	2060-Y60R		5294628					
	030 40 50	2570-Y90R	5267918			878675			
	3000	2570-Y90R		5264268					

\* Levereras med nylonnät på baksidan. Under vattenytan i bassänger bör man undvika nylonnät på plattans baksida då vidhäftningen mellan fix och platta kan försämrans. Välj istället papper på plattans framsida. Sista siffran i artikelnumret talar om att de levereras som ett ark med nylonnät på baksidan. Vill man ha papper på plattans framsida ersätt sista siffran med en 5:a.



# HÖGANÄS POOL COLLECTION

## GRYNNA

EN 14411 B1a OGLASERAD



### YTOR



Slät R10/B



SS R11/C



RC R11/C



RT R12/C



DD R12/C

### FÄRGER



G16 White  
NCS S 1505-Y40R



G06 Light Grey/Brown  
NCS S 4005-Y50R



G15 Medium Grey  
NCS S 6000-N



G30 Dark Grey  
NCS S 7000-N



14 Black  
NCS S 8000-N



G01 Beige  
NCS S 3005-Y20R



G05 Old Rose  
NCS S 3010-Y70R



G03 Yellow  
NCS S 3020-Y10R



G21 Ochre Yellow  
NCS S 3030-Y20R



25 Yellow/Lemon  
NCS S 2020-G90Y



G07 Light Grey/Blue  
NCS S 3502-Y



G19 Pink  
NCS S 3020-Y90R



G04 Caramel  
NCS S 5020-Y60R



G29 Coffe Brown  
NCS S 4010-G30Y



20 Brick Red  
NCS S 6020-Y90R



G27 Light Blue  
NCS S 4005-B20G



G11 Blu  
NCS S 4020-B



G13 Turquoise  
NCS S 3010-B70G



G28 Light Green  
NCS S 4010-G30Y



18 Green  
NCS S 6005-B80G



G26 Speckled White



G02 Speckled Grey



G24 Speckled Black/White



G23 Speckled Yellow

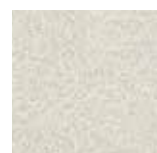

G17 Speckled Brown



G12 Granite Blue



G09 Granite Grey



G08 Granite Rose



G10 Granite Burgundy



G22 Granite Green

# HÖGANÄS POOL COLLECTION

## GRYNNA

EN 14411 B1a OGLASERAD



	Färger	NCS	M 10 x 10 cm (96x96x8 mm)					M 15 x 15 cm (146x146x8 mm)				
			Slät R10/B	RC R11/C	SS R11/C	DD R12/C	RT R12/C	Slät R10/B	RC R11/C	SS R11/C	DD R12/C	RT R12/C
	Beige	3005-Y20R	G01	G01 RC	G01 SS	G01 DD	G01 RT	G01 15	G01 RC 15	G01 SS 15	G01 DD 15	G01 RT 15
	Yellow	3020-Y10R	G03	G03 RC	G03 SS	G03 DD	G03 RT	G03 15	G03 RC 15	G03 SS 15	G03 DD 15	G03 RT 15
	Caramel	5020-Y60R	G04	G04 RC	G04 SS	G04 DD	G04 RT	G04 15	G04 RC 15	G04 SS 15	G04 DD 15	G04 RT 15
	Old Rose	3010-Y70R	G05	G05 RC	G05 SS	G05 DD	G05 RT	G05 15	G05 RC 15	G05 SS 15	G05 DD 15	G05 RT 15
	Light Grey/Brown	4005-Y50R	G06	G06 RC	G06 SS	G06 DD	G06 RT	G06 15	G06 RC 15	G06 SS 15	G06 DD 15	G06 RT 15
	Light Grey/Blue	3502-Y	G07	G07 RC	G07 SS	G07 DD	G07 RT	G07 15	G07 RC 15	G07 SS 15	G07 DD 15	G07 RT 15
	Blu	4020-B	G11	G11 RC	G11 SS	G11 DD	G11 RT	G11 15	G11 RC 15	G11 SS 15	G11 DD 15	G11 RT 15
	Turquoise	3010-B70G	G13	G13 RC	G13 SS	G13 DD	G13 RT	G13 15	G13 RC 15	G13 SS 15	G13 DD 15	G13 RT 15
	Black	8000-N	G14	G14 RC	G14 SS	G14 DD	G14 RT	G14 15	G14 RC 15	G14 SS 15	G14 DD 15	G14 RT 15
	Medium Grey	6000-N	G15	G15 RC	G15 SS	G15 DD	G15 RT	G15 15	G15 RC 15	G15 SS 15	G15 DD 15	G15 RT 15
	White	1505-Y40R	G16	G16 RC	G16 SS	G16 DD	G16 RT	G16 15	G16 RC 15	G16 SS 15	G16 DD 15	G16 RT 15
	Green	6005-B80G	G18	G18 RC	G18 SS	G18 DD	G18 RT	G18 15	G18 RC 15	G18 SS 15	G18 DD 15	G18 RT 15
	Pink	3020-Y90R	G19	G19 RC	G19 SS	G19 DD	G19 RT	G19 15	G19 RC 15	G19 SS 15	G19 DD 15	G19 RT 15
	Brick Red	6020-Y90R	G20	G20 RC	G20 SS	G20 DD	G20 RT	G20 15	G20 RC 15	G20 SS 15	G20 DD 15	G20 RT 15
	Ochre Yellow	3030-Y20R	G21	G21 RC	G21 SS	G21 DD	G21 RT	G21 15	G21 RC 15	G21 SS 15	G21 DD 15	G21 RT 15
	Yellow/Lemon	2020-G90Y	G25	G25 RC	G25 SS	G25 DD	G25 RT	G25 15	G25 RC 15	G25 SS 15	G25 DD 15	G25 RT 15
	Light Blue	4005-B20G	G27	G27 RC	G27 SS	G27 DD	G27 RT	G27 15	G27 RC 15	G27 SS 15	G27 DD 15	G27 RT 15
	Light Green	4010-G30Y	G28	G28 RC	G28 SS	G28 DD	G28 RT	G28 15	G28 RC 15	G28 SS 15	G28 DD 15	G28 RT 15
	Coffe Brown	7005-Y50R	G29	G29 RC	G29 SS	G29 DD	G29 RT	G29 15	G29 RC 15	G29 SS 15	G29 DD 15	G29 RT 15
	Dark Grey	7000-N	G30	G30 RC	G30 SS	G30 DD	G30 RT	G30 15	G30 RC 15	G30 SS 15	G30 DD 15	G30 RT 15
	Speckled Grey		G02	G02 RC	G02 SS	G02 DD	G02 RT	G02 15	G02 RC 15	G02 SS 15	G02 DD 15	G02 RT 15
	Granite Rose		G08	G08 RC	G08 SS	G08 DD	G08 RT	G08 15	G08 RC 15	G08 SS 15	G08 DD 15	G08 RT 15
	Granite Grey		G09	G09 RC	G09 SS	G09 DD	G09 RT	G09 15	G09 RC 15	G09 SS 15	G09 DD 15	G09 RT 15
	Granite Burgundy		G10	G10 RC	G10 SS	G10 DD	G10 RT	G10 15	G10 RC 15	G10 SS 15	G10 DD 15	G10 RT 15
	Granite Blue		G12	G12 RC	G12 SS	G12 DD	G12 RT	G12 15	G12 RC 15	G12 SS 15	G12 DD 15	G12 RT 15
	Speckled Brown		G17	G17 RC	G17 SS	G17 DD	G17 RT	G17 15	G17 RC 15	G17 SS 15	G17 DD 15	G17 RT 15
	Granite Green		G22	G22 RC	G22 SS	G22 DD	G22 RT	G22 15	G22 RC 15	G22 SS 15	G22 DD 15	G22 RT 15
	Speckled Yellow		G23	G23 RC	G23 SS	G23 DD	G23 RT	G23 15	G23 RC 15	G23 SS 15	G23 DD 15	G23 RT 15
	Speckled Black/White		G24	G24 RC	G24 SS	G24 DD	G24 RT	G24 15	G24 RC 15	G24 SS 15	G24 DD 15	G24 RT 15
	Speckled White		G26	G26 RC	G26 SS	G26 DD	G26 RT	G26 15	G26 RC 15	G26 SS 15	G26 DD 15	G26 RT 15



# HÖGANÄS **POOL** COLLECTION

## GRYNNA FORMBITAR

EN 14411 B1a OGLASERAD



# HÖGANÄS **POOL** COLLECTION

## GRYNNA FORMBITAR

EN 14411 B1a OGLASERAD



Alla formbitar finns i samtliga färger.

artikelnr. skrivs som färgkod + artikel, ex. G01 SB 15. Se färgkod på sidan 22

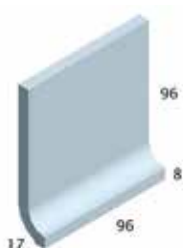

**HÅLKÄL**  
96x96x8 mm  
Artikel SB

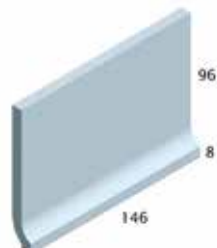

**HÅLKÄL**  
96x146x8 mm  
Artikel SB 15



**YTTERHÖRN**  
96x21x8 mm  
Artikel SBO



**INNERHÖRN**  
96x8 mm  
Artikel SBI

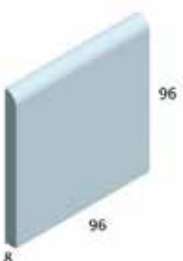

**RAK SOCKEL**  
96x96x8 mm  
Artikel BN

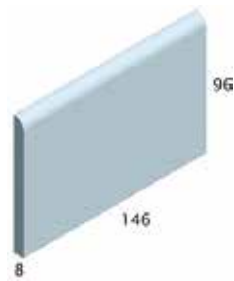

**RAK SOCKEL**  
96x146x8 mm  
Artikel BN 15

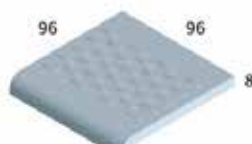

**TRAPPNOS**  
96x96x8 mm  
Artikel ST

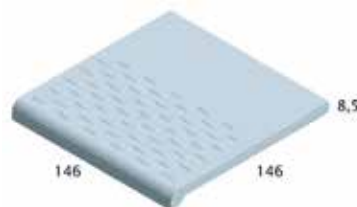

**TRAPPNOS**  
146x146x8 mm  
Artikel ST 15

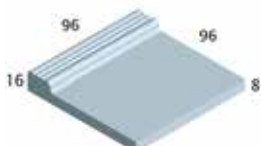

**GREPPKANTSPLATTA**  
96x96x8 mm  
Artikel PES

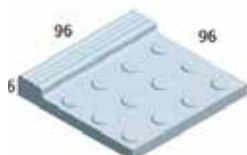

**GREPPKANTSPLATTA**  
96x96x8 mm  
Artikel PE

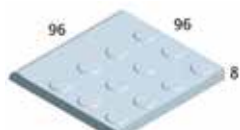

**KANTPLATTA**  
96x96x8 mm  
Artikel BNRC



**HÅLKÄLSPLATTA  
KONVEX**  
96x39x8 mm  
Artikel 24QR  
146x39x8 mm  
Artikel 26QR



**HÅLKÄLSPLATTA  
KONKAV**  
96x39x8 mm  
Artikel 24QR  
146x39x8 mm  
Artikel 26QR



**AVSLUTNINGSPLATTA  
UP-IN-CORNER**  
Artikel DOC/UIC



**3-VÅGS YTTERHÖRN  
DOWN-IN-CORNER**  
Artikel DOC/UIC



**3-VÅGS INNERHÖRN  
DOWN-IN-CORNER**  
Artikel DIC/UOC



**3-VÅGS INNERHÖRN  
UP-IN-CORNER**  
Artikel DIC/UOC

# HÖGANÄS **POOL** COLLECTION

## NATURA

EN 14411 A1a OGLASERAD





# HÖGANÄS POOL COLLECTION

## NATURA

EN 14411 A1b OGLASERAD



### SLÄT YTA

R10/B

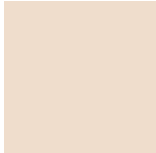

Naturbeige (892)  
NCS 2010-Y20R

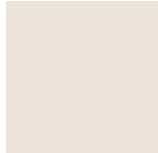

Naturweiss (890)  
NCS 2005-Y20R



Neutralgrau (894)  
NCS 3502-Y



Anthrazit (896)  
NCS 7500-N

### PROFILERAD YTA

R11/B

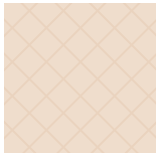

Naturbeige cross (893)  
NCS 2010-Y20R

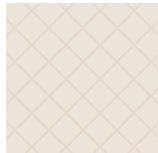

Naturweiss cross (891)  
NCS 2005-Y20R

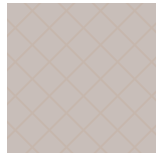

Neutralgrau cross (895)  
NCS 3502-Y



Anthrazit cross (897)  
NCS 7500-N

	EN 14411 Grupp B1a	NCS	M 12,5 x 25 cm (119x244x7,5 mm)		M 25 x 25 cm (244x244x7,5 mm)		M 12,5 x 12,5 cm (119x119x7,5 mm)	
			Slät R10/B	Profilerad R11/C	Slät R10/B	Profilerad R11/C	Slät R10/B	Profilerad R11/C
Naturbeige	2010-Y20R	31 1200 892	31 1200 893	32 2424 892	32 2424 893	32 1212 892	32 1212 893	
Naturweiss	2005-Y20R	31 1200 890	31 1200 891	32 2424 890	32 2424 891	32 1212 890	32 1212 891	
Neutralgrau	3502-Y	31 1200 894	31 1200 895	32 2424 894	32 2424 895	32 1212 894	32 1212 895	
Anthrazit	7500-N	31 1200 896	31 1200 897	32 2424 896	32 2424 897	32 1212 896	32 1212 897	

## NATURA FORMBITAR

EN 14411 A1a OGLASERAD

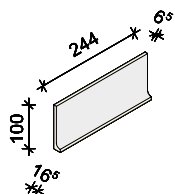

**SOCKEL SLÄT R10/B**  
244x100x6,5 mm

66 4000 892 Naturbeige  
66 4000 890 Naturweiss  
66 4000 894 Neutralgrey  
66 4000 896 Antrazit

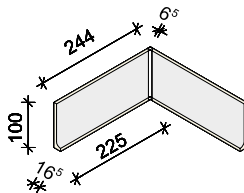

**INNERHÖRN**  
244x100x6,5 mm

66 4000 892 Naturbeige  
66 4000 890 Naturweiss  
66 4000 894 Neutralgrey  
66 4000 896 Antrazit

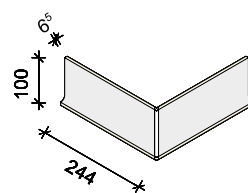

**YTTERHÖRN**  
244x100x6,5 mm

66 4000 892 Naturbeige  
66 4000 890 Naturweiss  
66 4000 894 Neutralgrey  
66 4000 896 Antrazit

# HÖGANÄS **POOL** COLLECTION

## TRAPPSTEGSPLATTOR

EN 14411 A1a



OBS. Säkerhetsmarkering finns i färgerna azurblau (788), azur dunkel (798) och schwarz (998).  
Artikeln skrivs då enligt följande exempel: 66 3196 906-788. Vit matt ribbad kantplatta med azurblå säkerhetsmarkering.  
Önskas andra färger kan det eventuellt fås vid förfrågan.

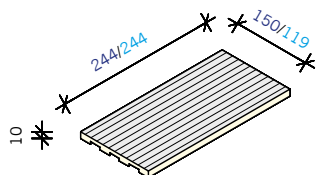

**BRED RIBBAD PLATTA C YTA**  
150x244x10 mm

66 3190 690 Oglaserad  
66 3190 906 Vit matt

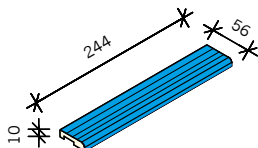

**RIBBAD MARKERINGSPLATTA C YTA**  
150x244x10mm

36 3195-FC

**SMAL RIBBAD PLATTA C YTA**  
119x244x10 mm

66 3130 690 Oglaserad  
66 3130 906 Vit matt

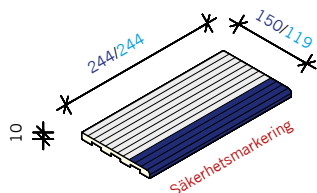

**BRED RIBBAD KANTPLATTA C YTA**  
150x244x10 mm

66 3196 690 Oglaserad uden markering  
66 3196 690-FC Oglaserad med markering  
66 3196 906 Vit matt uden markering  
66 3196 906-FC Vit matt med markering

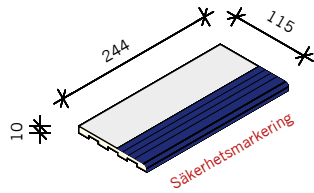

**RIBBAD KANTPLATTA C YTA**  
115x244x10 mm

66 4710 690 Oglaserad  
66 4710 690-FC Oglaserad med markering  
66 4710 906 Vit matt  
66 4710 906-FC Vit matt med markering

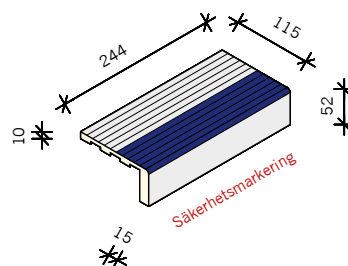

**RIBBAD KANTPLATTA C YTA**  
115x244x10/52 mm

66 5700 690 Oglaserad  
66 5700 690-FC Oglaserad med markering  
66 5700 906 Vit matt  
66 5700 906-FC Vit matt med markering

**SMAL RIBBAD KANTPLATTA C YTA**  
119x244x10 mm

66 3136 690 Oglaserad  
66 3136 906 Vit matt





# HÖGANÄS **POOL** COLLECTION

## UPPLAGSPLATTOR

EN 14411 B1a

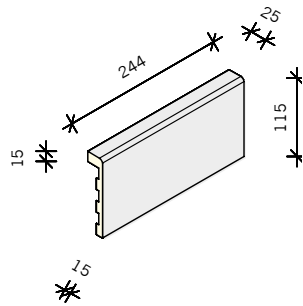

### UPPLAGSPLATTA 90°

115x244 mm

66 9039 901 Vit matt  
66 9039 900 Vit blank

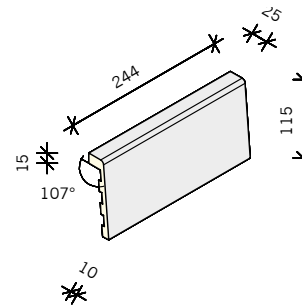

### UPPLAGSPLATTA 90°

115x244 mm

66 9050 901 Vit matt  
66 9050 900 Vit blank

## GOLVRÄNNOR

EN 14411 A1a

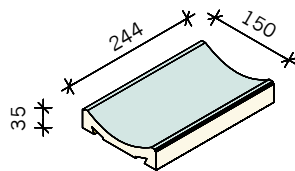

### GOLVRÄNNA

150x244 mm

66 4500 690 Oglaserad  
66 4500 908 Vit matt

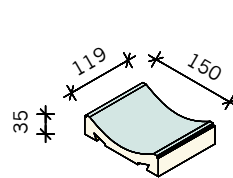

### GOLVRÄNNA HALV

150x119 mm

66 4505 690 Oglaserad  
66 4505 908 Vit matt

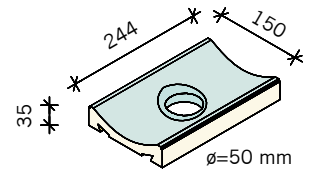

### GOLVRÄNNA MED UTLOPP

150x244 mm

66 4501 690 Oglaserad  
66 4501 908 Vit matt

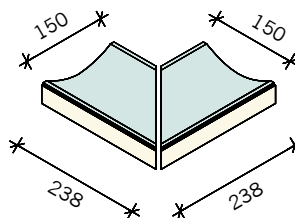

### YTTERHÖRN

150x238 mm

66 4502 690 Oglaserad  
66 4502 908 Vit matt

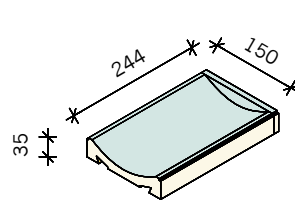

### GOLVRÄNNA STOPP

150x244 mm

66 4504 690 Oglaserad  
66 4504 908 Vit matt

# HÖGANÄS **POOL** COLLECTION

## FINNISH SYSTEM

HÖG VATTENNIVÅ



Denna typ av ränna är den mest förekommande utformningen av större bassänger idag. Bassängens vattenyta ligger på samma nivå som omgivande golvytor. Kanten mellan rännan och bassängen utformas med en lutning på ca 8° för att ge en vågdämpad effekt. Den lutande kantens bredd kan varieras beroende på bassängens storlek och önskemål på den vågdämpade effekten.

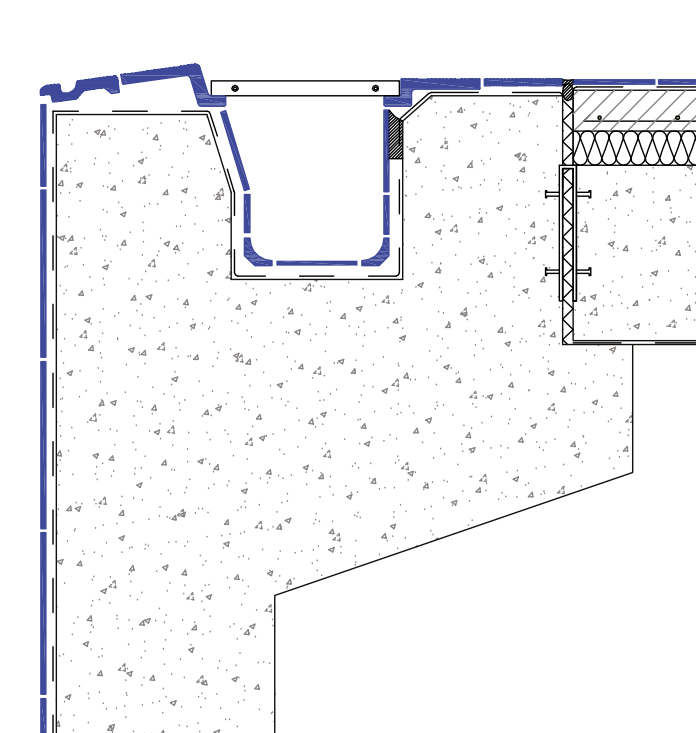

# HÖGANÄS POOL COLLECTION

## FINNISH SYSTEM

HÖG VATTENNIVÅ



OBS. Säkerhetsmarkering finns i färgerna azurblau (788), azur dunkel (798) och schwarz (998).  
 Artikeln skrivs då enligt följande exempel: 66 3196 906-788. Vit matt ribbad kantplatta med azurblå säkerhetsmarkering.  
 Önskas andra färger kan det eventuellt fås vid förfrågan.

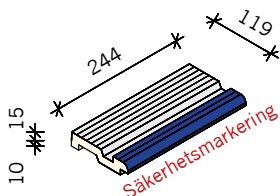

**GREPPKANTSPLATTA C YTA**  
**119x244 mm**

- 66 5730 690 Oglaserad utan markering
- 66 5730 690-FC Oglaserad med markering
- 66 5730 906 Vit matt utan markering
- 66 5730 906-FC Vit matt med markering

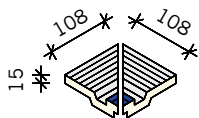

**INNERHÖRN C YTA**  
**108x108 mm**

- 66 5732 690 Oglaserad utan markering
- 66 5732 690-FC Oglaserad med markering
- 66 5732 906 Vit matt utan markering
- 66 5732 906-FC Vit matt med markering

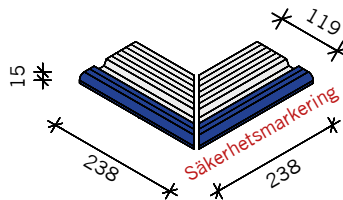

**YTTERHÖRN C YTA**  
**119x238 mm**

- 66 5737 690 Oglaserad utan markering
- 66 5737 690-FC Oglaserad med markering
- 66 5737 906 Vit matt utan markering
- 66 5737 906-FC Vit matt med markering

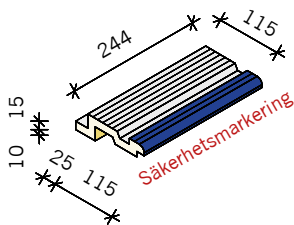

**GREPPKANTSPLATTA C YTA**  
**115x244 mm**

- 66 5810 690 Oglaserad utan markering
- 66 5810 690-FC Oglaserad med markering
- 66 5810 906 Vit matt utan markering
- 66 5810 906-FC Vit matt med markering

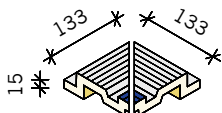

**INNERHÖRN C YTA**  
**133x133 mm**

- 66 5812 690 Oglaserad utan markering
- 66 5812 690-FC Oglaserad med markering
- 66 5812 906 Vit matt utan markering
- 66 5812 906-FC Vit matt med markering

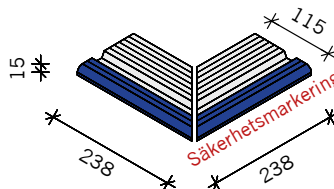

**YTTERHÖRN C YTA**  
**115x238 mm**

- 66 5817 690 Oglaserad utan markering
- 66 5817 690-FC Oglaserad med markering
- 66 5817 906 Vit matt utan markering
- 66 5817 906-FC Vit matt med markering

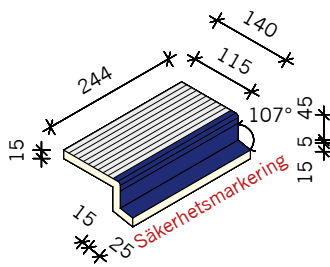

**UPPLAGSPLATTA C YTA**  
**140x244x65 mm**

- 66 5820 690 Oglaserad utan markering
- 66 5820 690-FC Oglaserad med markering
- 66 5820 906 Vit matt utan markering
- 66 5820 906-FC Vit matt med markering

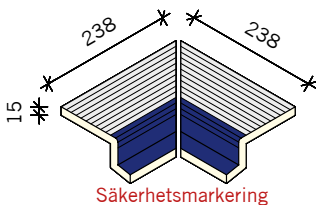

**INNERHÖRN C YTA**  
**108x108x65 mm**

- 66 5822 690 Oglaserad utan markering
- 66 5822 690-FC Oglaserad med markering
- 66 5822 906 Vit matt utan markering
- 66 5822 906-FC Vit matt med markering

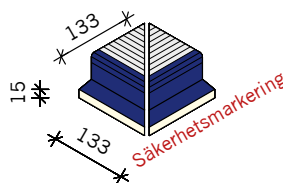

**YTTERHÖRN C YTA**  
**133x133x65 mm**

- 66 5827 690 Oglaserad utan markering
- 66 5827 690-FC Oglaserad med markering
- 66 5827 906 Vit matt utan markering
- 66 5827 906-FC Vit matt med markering

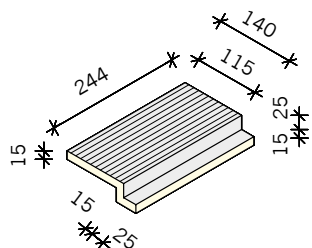

**UPPLAGSPLATTA C YTA**  
**140x244x40 mm**

- 66 5830 690 Oglaserad
- 66 5830 906 Vit matt

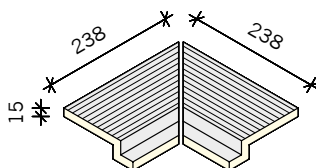

**INNERHÖRN C YTA**  
**238x238x40 mm**

- 66 5832 690 Oglaserad
- 66 5832 906 Vit matt

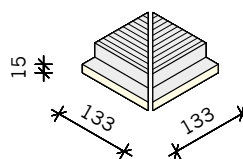

**YTTERHÖRN C YTA**  
**133x133x40 mm**

- 66 5837 690 Oglaserad
- 66 5837 906 Vit matt

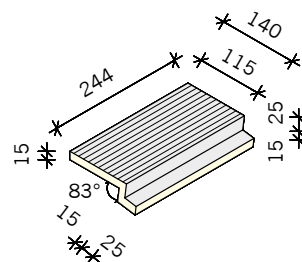

**UPPLAGSPLATTA C YTA**  
**140x244x40 mm**

- 66 5930 690 Oglaserad
- 66 5930 906 Vit matt

# HÖGANÄS **POOL** COLLECTION

## ZÜRICH SYSTEM HÖG VATTENNIVÅ



En enkel konstruktion i jämförelse med andra system. Kanten ger ett mycket bra grepp för de badande. Kanten ger ingen vågdämpande effekt och lämpar sig bäst för mindre bassänger.

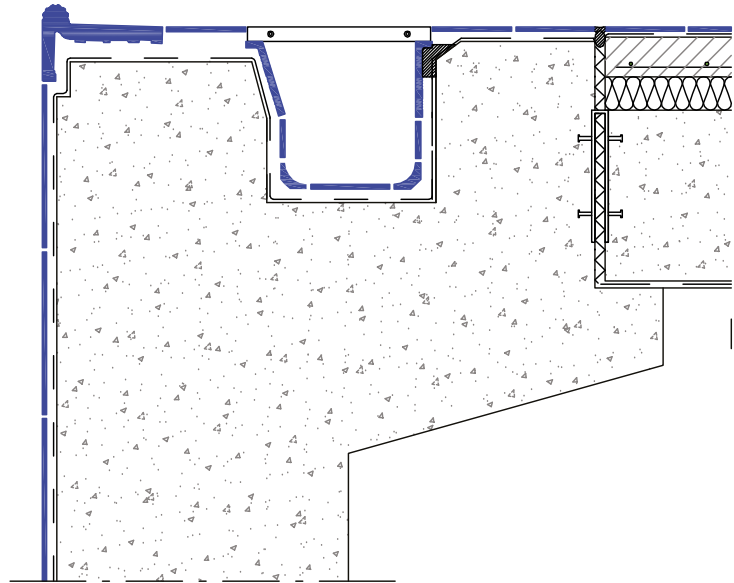

# HÖGANÄS POOL COLLECTION

## ZÜRICH SYSTEM HÖG VATTENNIVÅ



OBS. Säkerhetsmarkering finns i färgerna azurblau (788), azur dunkel (798) och schwarz (998).

Artikeln skrivs då enligt följande exempel: 66 3196 906-788. Vit matt ribbad kantplatta med azurblå säkerhetsmarkering. Önskas andra färger kan det eventuellt fås vid förfrågan.

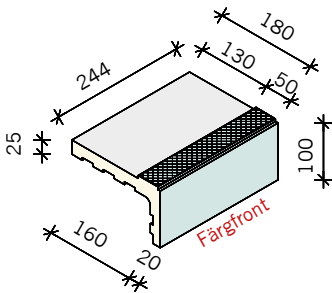

**GREPPKANTSPLOTTA C YTA**  
180x244x100 mm

- 66 5400 690 Oglaserad utan markering
- 66 5400 690-FC Oglaserad med markering
- 66 5400 906 Vit matt utan markering
- 66 5400 906-FC Vit matt med markering

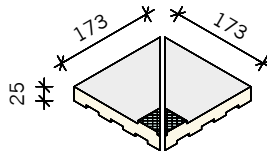

**INNERHÖRN C YTA**  
173x173 mm

- 66 5402 690 Oglaserad utan markering
- 66 5402 690-FC Oglaserad med markering
- 66 5402 906 Vit matt utan markering
- 66 5402 906-FC Vit matt med markering

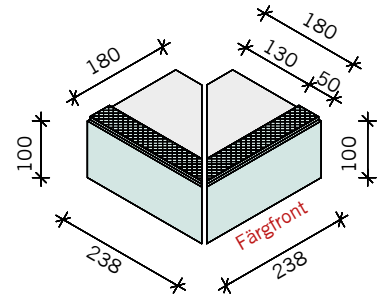

**YTTERHÖRN C YTA**  
180x238x100 mm

- 66 5407 690 Oglaserad utan markering
- 66 5407 690-FC Oglaserad med markering
- 66 5407 906 Vit matt utan markering
- 66 5407 906-FC Vit matt med markering

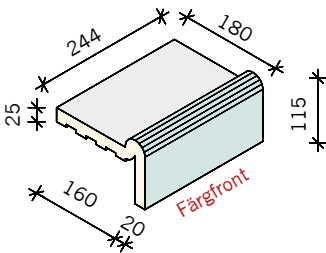

**GREPPKANTSPLOTTA C YTA**  
180x244x115 mm

- 66 5450 690 Oglaserad utan markering
- 66 5450 690-FC Oglaserad med markering
- 66 5450 906 Vit matt utan markering
- 66 5450 906-FC Vit matt med markering

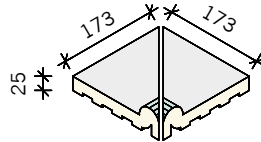

**INNERHÖRN C YTA**  
173x173 mm

- 66 5452 690 Oglaserad utan markering
- 66 5452 690-FC Oglaserad med markering
- 66 5452 906 Vit matt utan markering
- 66 5452 906-FC Vit matt med markering

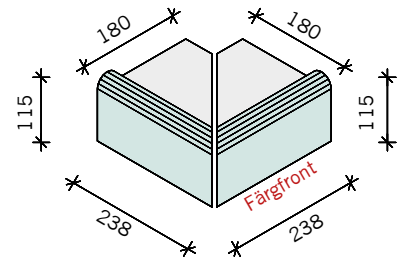

**YTTERHÖRN C YTA**  
180x238x115 mm

- 66 5457 690 Oglaserad utan markering
- 66 5457 690-FC Oglaserad med markering
- 66 5457 906 Vit matt utan markering
- 66 5457 906-FC Vit matt med markering

Formbit där den horisontella plana ytan bekläs med andra lämpliga plattor

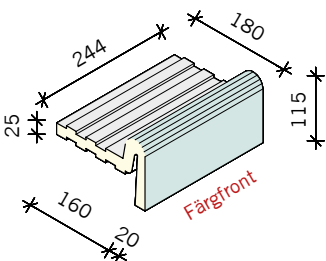

**GREPPKANTSPLOTTA**  
180x244x115 mm

- 66 5460 690 Oglaserad utan markering
- 66 5460 690-FC Oglaserad med markering
- 66 5460 906 Vit matt utan markering
- 66 5460 906-FC Vit matt med markering

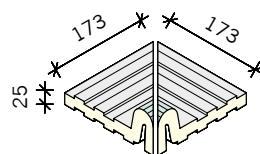

**INNERHÖRN**  
173x173 mm

- 66 5462 690 Oglaserad utan markering
- 66 5462 690-FC Oglaserad med markering
- 66 5462 906 Vit matt utan markering
- 66 5462 906-FC Vit matt med markering

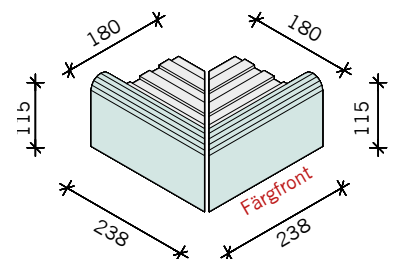

**YTTERHÖRN**  
180x238x115 mm

- 66 5467 690 Oglaserad utan markering
- 66 5467 690-FC Oglaserad med markering
- 66 5467 906 Vit matt utan markering
- 66 5467 906-FC Vit matt med markering

# HÖGANÄS **POOL** COLLECTION

## WIESBADEN SYSTEM HÖG VATTENNIVÅ

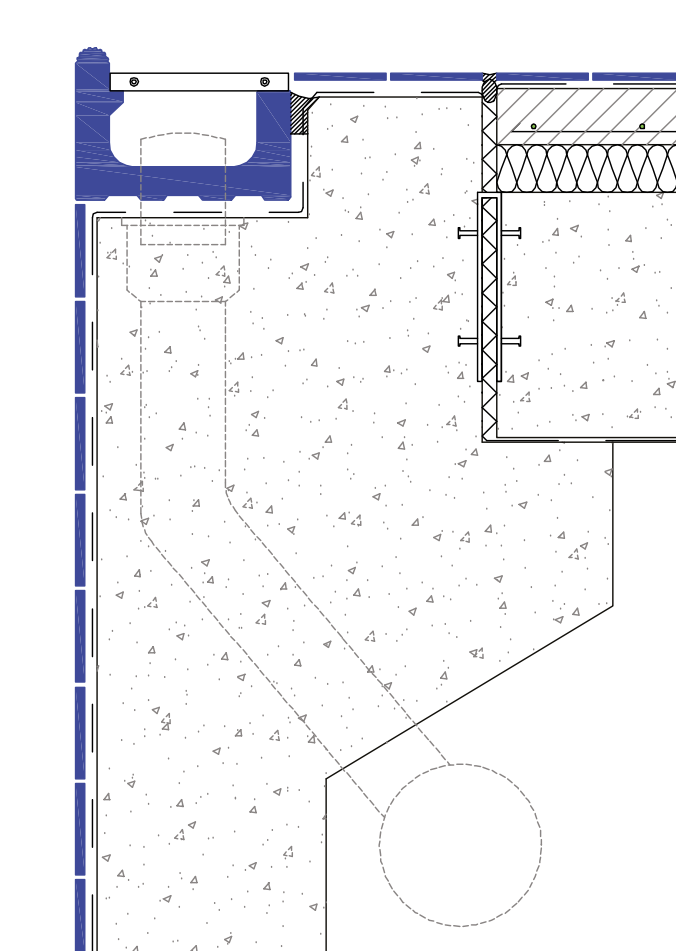

Denna kantlösning används då bassängens vattenyta önskas ligga i nivå med omgivande golvytor. Här ställs inga krav på den vågdämpande effekten, som en lutande kant ger (Finnish channel). Rännan är formad i ett stycke med en säker greppkant för simmaren.





# HÖGANÄS POOL COLLECTION

## WIESBADEN SYSTEM

HÖG VATTENNIVÅ



Önskas andra färger kan det fås vid förfrågan. Se färgkod på sidan 11

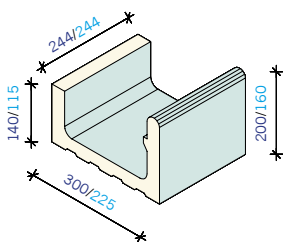

### BRED SKVALPRÄNNA 300x244x200/140 mm

66 5300 901 Vit matt  
66 5300 900 Vit blank  
66 5300 710 Ljusblå blank  
66 5300 +FC

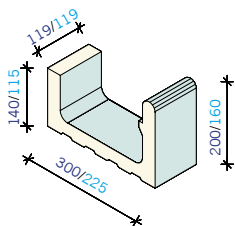

### BRED SKVALPRÄNNA KORT 300x119x200/140 mm

66 5305 901 Vit matt  
66 5305 900 Vit blank  
66 5305 710 Ljusblå blank  
66 5305 +FC

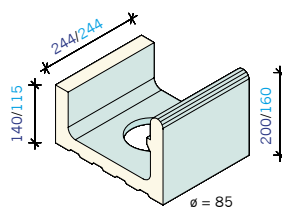

### BRED SKVALPRÄNNA MED UTLOPP 300x244x200/140 mm

66 5301 901 Vit matt  
66 5301 900 Vit blank  
66 5301 710 Ljusblå blank  
66 5301 +FC

### SMAL SKVALPRÄNNA 225x244x160/115 mm

66 5170 901 Vit matt  
66 5170 900 Vit blank  
66 5170 710 Ljusblå blank  
66 5170 +FC

### SMAL SKVALPRÄNNA KORT 225x119x160/115 mm

66 5175 901 Vit matt  
66 5175 900 Vit blank  
66 5175 710 Ljusblå blank  
66 5175 +FC

### SMAL SKVALPRÄNNA MED UTLOPP 225x244x160/115 mm

66 5171 901 Vit matt  
66 5171 900 Vit blank  
66 5171 710 Ljusblå blank  
66 5171 +FC

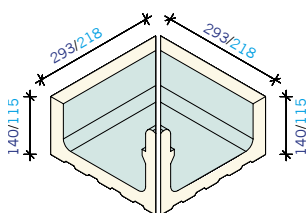

### BRED SKVALPRÄNNA INNERHÖRN 300x293x200/140 mm

66 5302 901 Vit matt  
66 5302 900 Vit blank  
66 5302 710 Ljusblå blank  
66 5302 +FC

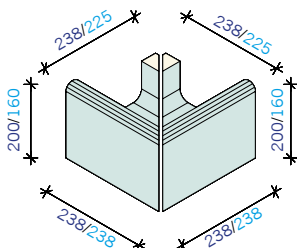

### BRED SKVALPRÄNNA YTTERHÖRN 300x238x200/140 mm

66 5307 901 Vit matt  
66 5307 900 Vit blank  
66 5307 710 Ljusblå blank  
66 5307 +FC

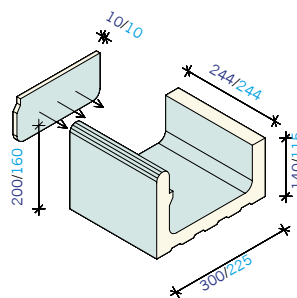

### BRED SKVALPRÄNNA MED AVSLUT VÄNSTER 300x244x200/140 mm

66 5304 901 Vit matt  
66 5304 900 Vit blank  
66 5304 710 Ljusblå blank  
66 5304 +FC

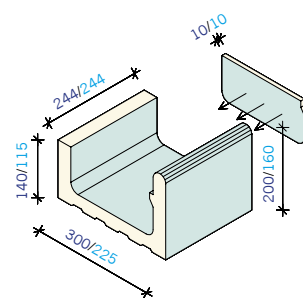

### BRED SKVALPRÄNNA MED AVSLUT HÖGER 300x244x200/140 mm

66 5306 901 Vit matt  
66 5306 900 Vit blank  
66 5306 710 Ljusblå blank  
66 5306 +FC

### SMAL SKVALPRÄNNA INNERHÖRN 225x218x160/115 mm

66 5172 901 Vit matt  
66 5172 900 Vit blank  
66 5172 710 Ljusblå blank  
66 5172 +FC

### SMAL SKVALPRÄNNA YTTERHÖRN 225x238x160/115 mm

66 5177 901 Vit matt  
66 5177 900 Vit blank  
66 5177 710 Ljusblå blank  
66 5177 +FC

### SMAL SKVALPRÄNNA MED AVSLUT VÄNSTER 225x244x160/115 mm

66 5174 901 Vit matt  
66 5174 900 Vit blank  
66 5174 710 Ljusblå blank  
66 5174 +FC

### SMAL SKVALPRÄNNA MED AVSLUT HÖGER 225x244x160/115 mm

66 5176 901 Vit matt  
66 5176 900 Vit blank  
66 5176 710 Ljusblå blank  
66 5176 +FC

# HÖGANÄS **POOL** COLLECTION

## WIESBADEN SYSTEM LÅG VATTENNIVÅ

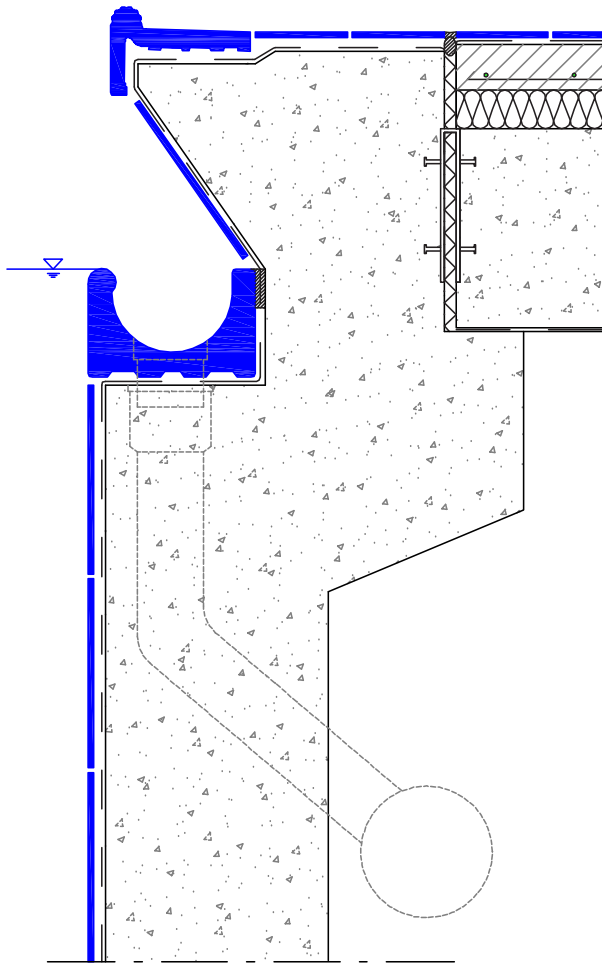

Användningen av detta kantutförande innebär att vattenytan kommer att ligga 20-30cm under golvnivån. Den ger en enkel och välfungerande lösning för utloppsystemet, samtidigt som simmaren får en utmärkt greppkant.



# HÖGANÄS POOL COLLECTION

## WIESBADEN SYSTEM

LÅG VATTENNIVÅ



Önskas andra färger kan det fås vid förfrågan. Se färgkod på sidan 11

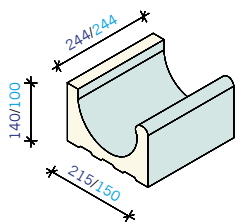

**BRED SKVALPRÄNNA**  
215x244x140 mm

66 5100 901 Vit matt  
66 5100 900 Vit blank  
66 5100 710 Ljusblå blank  
66 5100 +FC

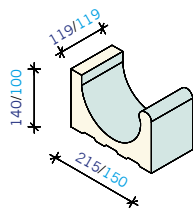

**BRED SKVALPRÄNNA KORT**  
215x119x140 mm

66 5105 901 Vit matt  
66 5105 900 Vit blank  
66 5105 710 Ljusblå blank  
66 5105 +FC

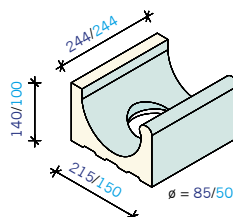

**BRED SKVALPRÄNNA MED UTLOPP**  
215x244x140 mm

66 5101 901 Vit matt  
66 5101 900 Vit blank  
66 5101 710 Ljusblå blank  
66 5101 +FC

**SMAL SKVALPRÄNNA**  
150x244x100 mm

66 5110 901 Vit matt  
66 5110 900 Vit blank  
66 5110 710 Ljusblå blank  
66 5110 +FC

**SMAL SKVALPRÄNNA KORT**  
150x119x100 mm

66 5115 901 Vit matt  
66 5115 900 Vit blank  
66 5115 710 Ljusblå blank  
66 5115 +FC

**SMAL SKVALPRÄNNA MED UTLOPP**  
150x244x100 mm

66 5111 901 Vit matt  
66 5111 900 Vit blank  
66 5111 710 Ljusblå blank  
66 5111 +FC

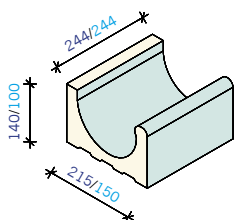

**BRED SKVALPRÄNNA**  
INNERHÖRN  
215x208x140 mm

66 5102 901 Vit matt  
66 5102 900 Vit blank  
66 5102 710 Ljusblå blank  
66 5102 +FC

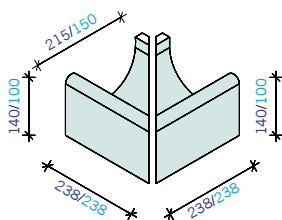

**BRED SKVALPRÄNNA**  
YTTERHÖRN  
215x238x140 mm

66 5107 901 Vit matt  
66 5107 900 Vit blank  
66 5107 710 Ljusblå blank  
66 5107 +FC

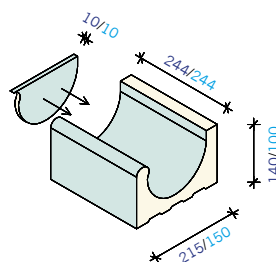

**BRED SKVALPRÄNNA**  
MED AVSLUT VÄNSTER  
215x244x140 mm

66 5104 901 Vit matt  
66 5104 900 Vit blank  
66 5104 710 Ljusblå blank  
66 5104 +FC

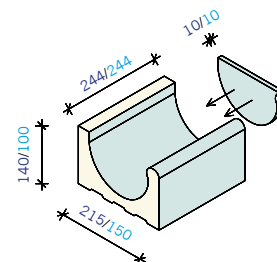

**BRED SKVALPRÄNNA**  
MED AVSLUT HÖGER  
215x244x140 mm

66 5104 901 Vit matt  
66 5104 900 Vit blank  
66 5104 710 Ljusblå blank  
66 5104 +FC

**SMAL SKVALPRÄNNA**  
INNERHÖRN  
150x143x100 mm

66 5112 901 Vit matt  
66 5112 900 Vit blank  
66 5112 710 Ljusblå blank  
66 5112 +FC

**SMAL SKVALPRÄNNA**  
YTTERHÖRN  
150x238x100 mm

66 5117 901 Vit matt  
66 5117 900 Vit blank  
66 5117 710 Ljusblå blank  
66 5117 +FC

**SMAL SKVALPRÄNNA**  
MED AVSLUT VÄNSTER  
150x244x100 mm

66 5114 901 Vit matt  
66 5114 900 Vit blank  
66 5114 710 Ljusblå blank  
66 5114 +FC

**SMAL SKVALPRÄNNA**  
MED AVSLUT HÖGER  
150x244x100 mm

66 5114 901 Vit matt  
66 5114 900 Vit blank  
66 5114 710 Ljusblå blank  
66 5114 +FC

# HÖGANÄS **POOL** COLLECTION

## MARKERINGSPLATTOR



Text, signal och sifferplattor tillverkas efter förfrågan.  
Kontakta din säljrepresentant för mer information

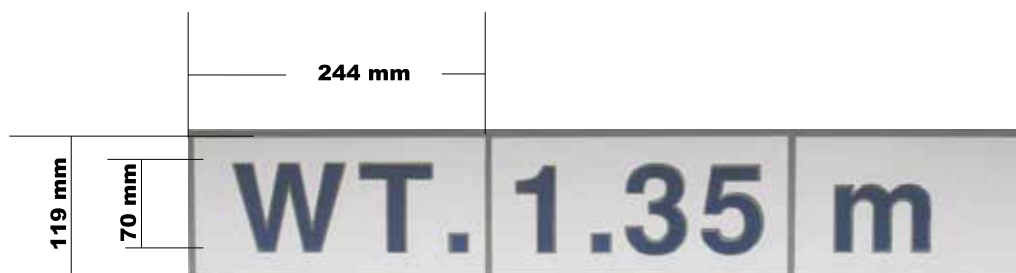



# TÄTSKIKTSSYSTEM FÖR BASSÄNGER

Eventuell spackling av bassängbotten

- Prima med **Mapepoxy L**
- Spackla med **Confix**

Eventuell putsning och primning av bassängvägg

- Prima/slamma med **Redisit**
- Putsa med **Redirep 45 RSF**

Innan tätskikt

- Gör urfräsning runt genomföringar. Urfräsningen ska vara minst 50 mm bred och minst 30 mm djup. Fyll urfräsningen med **Adesilex PG1** som mättas med **kvartmix 0,4 - 1,4mm**

Tätskikt

- Tätskikta med **Mapelastic** tillsammans med **Mapenet 150** alt. **Mapetex Sel**
- Till skarvar och golv/vägg vinklar ska **Mapeband** användas

Plattsättning

- Plattsättning görs med **Elastorapid** alt. **Ultralite S1**

Fogning

- Foga med cementbaserad fog **Ultracolor Plus** alt. epoxibaserad fog **Kerapoxy Design/CQ** alt. **Habenit 60**

Se produktsammansättningen på nästa sida

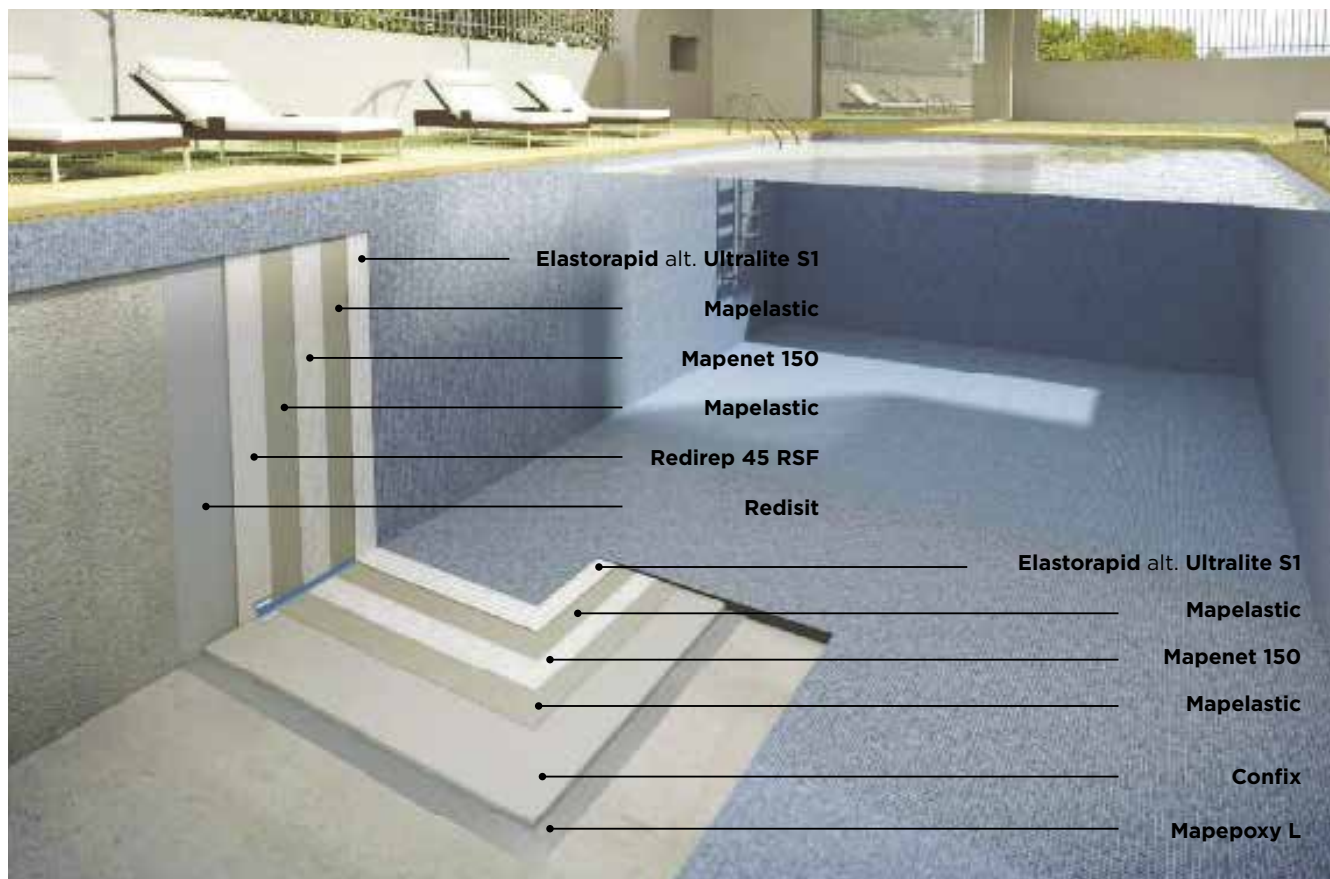

# PRODUKT SAMMANSTÄLLNING

Produkt	Användning	Åtgång/m <sup>2</sup>
<b>Spackling och putsning</b>		
Mapepoxy L	Primning före spackling av golv	2 kg/l
Confix	Avjämningsmassa för golv 10 - 50 mm	ca 2 kg/l
Redisit	Vidhäftningsslamma / korrosionsskydd	1,0 kg
Redirep 45 RSF	Betongreparationsbruk 5 - 50 mm	1,8 kg/dm <sup>3</sup>
<b>Tätning/tätskikt</b>		
Adesilex PG1	Epoxibaserat spackelbruk	1,65 - 1,75 kg/m <sup>2</sup> mm
Kvartsmix 0,4 - 1,4 mm	Fyllmedel till epoxiplugg	
Mapelastic	Spacklingsbart membran total tjocklek 2 mm	3,4 kg
Mapenet 150	Glasfibernet	1,05 m/m
Mapetex Sel	Nonwoven förstärkningsduk till membran	1,05 m/m
Mapeband	Tätband vinklar, skarvar, dillationsfogar	1 m/m
Mapei VR manschetter	Tät detaljer, rörmanschetter	
<b>Plattsättning</b>		
Elastorapid	Cementbaserad snabbfästmassa C2FTE / S2	3,5 - 5 kg
Ultralite S1	Cementbaserad fästmassa C2TE / S1	2,5 - 4 kg
<b>Fogning</b>		
Ultracolor plus	Cementbasead fogmassa	0,8 - 1 kg
Kerapoxy / Kerapoxy Design	Epoxibaserad fogmassa	1,0 - 1,5 kg
Habenit 60	Epoxibaserad fogmassa	0,8 - 1,3 kg
Mapesil AC	Rörelsefog	3,1 m/ 310 ml





**Höganäs**  
RICCHETTI GROUP

[WWW.CCHOGANAS.SE](http://WWW.CCHOGANAS.SE)

CC HÖGANÄS BYGGKERAMIK AB, BOX 501, 267 75 EKEBY  
TEL 077-447 35 00 FAX 077-447 36 46 INFO@CCHOGANAS.SE